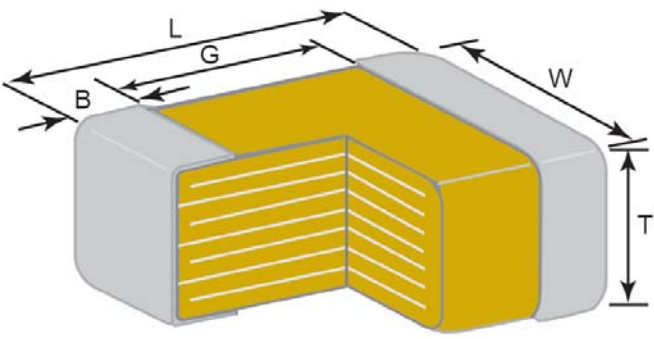
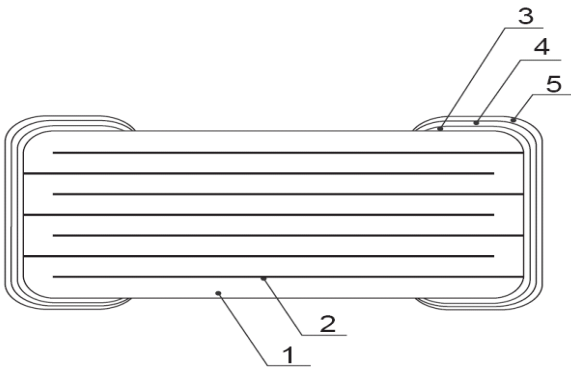

# TDK MLCC DATASHEET

C1005	X6S	0G	225	M	T	XXXX
(1)	(2)	(3)	(4)	(5)	(6)	(7)

NO.	SEGMENT	DETAIL	COMMENTS
(1)	Case Size (mm)	1.0 x 0.5	See below for dimensions
(2)	Temperature Characteristic	-55°C to 105°C, ± 15%	Class II; Conforms to EIA 198
(3)	Rated Voltage (V)	4	DC
(4)	Capacitance (pF)	2,200,000	1st & 2nd are significant figures; 3rd is multiplier
(5)	Capacitance Tolerance (%) or pF	± 20%	Conforms to IEC 384-9
(6)	Packaging Information	Tape and Reel	EIA 481 format
(7)	TDK Internal Code	XXXX	(Internal TDK use only)
-	Quality Factor (Q)	-	-
-	Dissipation Factor (DF)	10.0% Max	1.0 ± 0.2 Vrms, 1kHz ± 10%
-	Insulation Resistance	200 MΩ Min	Apply rated voltage for 60 seconds at 25°C

Condition for life : Apply rated voltage at maximum operating temperature ±2°C for 1,000 +48,-0hr.

PHYSICAL DIMENSIONS		MATERIAL SYSTEM			
					
SYMBOL	DIMENSIONS (mm)	NO.	NAME	MATERIAL	
				CLASS I	CLASS II/III
L	1.00 +/-0.05	(1)	Dielectric	CaZrO3	BaTiO3
W	0.50 +/-0.05	(2)	Electrode	Ni	Ni
T	0.50 +/-0.05	(3)	Termination	Cu	Cu
B	0.25 +0.05,-0.10	(4)		Ni	Ni
G	0.35 MIN.	(5)		Sn	Sn

<sup>1</sup> This datasheet is to be used for reference purposes only and is subject to change by TDK without notice. It reflects an overview of the product characteristics/performance for the particular part number. For product specification information, please refer to TDK's general product specification. Please note that this standard part is not designed or warranted to meet any specifications of any intermediate or end user different from or in addition to the specifications set forth in TDK's general product specification. Note also that this standard part has not been specially designed or manufactured for, nor is it intended or warranted for use in, or permitted to be resold for, specialized applications such as aviation, medical, and/or governmental/military applications (collectively, "Excluded Applications"). Picture of capacitor is for illustration only and may not reflect the product's actual appearance.